

**A Computational Model of Speciation
in Non-Uniform Environments
Without Physical Barriers.**

Ezequiel A. Di Paolo
School of Cognitive and Computing Sciences
University of Sussex, BRIGHTON BN1 9QH, U.K.

by the effects of population dynamics, ecological factors, and localized interactions between the individuals and the environment. This fact suggests that explanations focusing only on certain dimensions of the process will in general fail to grasp completely its complex dynamics.

The purpose of the computational model presented here is precisely to try to capture some of the emergent features of speciation that are missed for this reason by purely analytical/stochastic models and verbal arguments. These usually try to describe the speciation process at a population level. By means of computer simulations many features can be modelled at a lower level (in this case at the level of the individual) and effects at the collective level can be expected as a result.

Computational models of this kind have many advantages, not the least important of which are their flexibility and their capability of expanding the range of questions that can be explored; questions that are very hard to answer by more traditional analytical means. Such questions include the effect of environmental variations in space and time and the effect of the distribution of resources.

However it is unreasonable to expect purely computational models to replace other kinds of explanations due to the difficulty (or even impossibility) of translating all the relevant features of the natural world into a computer program. It is the hope of the people working with these kinds of model to be able to support and extend existing arguments not fully supported by the existing empirical observations, possibly by adding qualitative considerations arising from an approximation to the dynamics of the real case.

2 Modes of Speciation

In biological research a species is traditionally defined as a “*group of actually or potentially interbreeding populations which are reproductively isolated from other such groups*” (Mayr, 1963). In other words a biological species can be characterized by the genetic differences that prevent genetic flow to and from another species. Despite its objectivity the use of this definition can meet several practical problems as discussed by Barton (Barton, 1988), and in general morphological features are used to make distinctions between species, although it is possible for two organisms to be morphologically very similar and yet be unable to exchange genes. However, when it comes to understanding the mechanisms by which two populations sharing a common ancestor become reproductively incompatible, the biological species defini-

tion provides an objective ground.

The problem of speciation is interesting because it is counter-intuitive to think of populations moving from one adaptive peak to another without passing through a valley of low fitness and being eliminated by natural selection. However if the gene flow between two populations of a given species is somehow diminished or interrupted for a sufficiently long time, then both populations may be able to accumulate a certain number of non-maladaptive but incompatible mutations. This is known as the Dobzhansky-Muller model of speciation (Dobzhansky, 1936, 1951; Muller, 1962; Orr, 1995). According to this model when two populations starting with identical genotypes at certain loci (aa,bb) become isolated (the simplest case is with two allopatric populations, i.e. geographically isolated), an A mutation may appear in one of them and be fixed, that is to say that Aabb and AAbb genotypes are viable, and also a B mutation may appear and remain fixed in the other population. Then, although, Aabb, AAbb, aaBb and aaBB genotypes may be perfectly viable and fertile, the A and B alleles may produce a deleterious effect together in the same genotype, resulting in hybrid inviability or infertility (Orr, 1995).

Of course this does not have to happen, but as shown by Orr when more loci are substituted the interactions become more complicated and the probability of incompatibility increases faster than linearly with this number. Incompatibilities are more likely to happen between substituted and “untested” alleles.

As mentioned above, the simplest isolating mechanism, is when the two populations are allopatric. This usually happens when some kind of geographical accident (a river, a mountain, an island, etc.) acts as a barrier between populations of a given species. In this case gene flow is physically interrupted as it is impossible or highly unlikely for individual members to cross the barrier. Depending on the relative sizes of the isolated populations it is possible to identify two extremes in allopatric speciation: when the populations are large and similar in size (the dumbbell model) and when a strong disparity exists in population numbers. The unbalanced genetic pool in the “founder” population in the latter case provokes many interesting effects leading to rapid speciation, also called peripatric speciation (Mayr, 1954).

It is still possible, however, for speciation to occur even if a certain level of gene flow is allowed to exist between populations, thus relaxing the assumption of purely allopatric populations. A species that is continuously distributed in a large habitat may be faced with different selection pressures

in different regions of this habitat, thus favouring localized selection and providing a mechanisms for (at least partial) reproductive isolation. This is mainly due to the low fitness of individuals moving out of their local environment. This case is known as parapatric speciation. Whether this is not allopatric in a general sense is a semantic issue. However, some people remain doubtful about how many of the supposedly parapatric speciation cases observed in nature are not the result of previous isolation of populations that expanded their ranges later in evolutionary history (see Mayr, 1988).

Non-geographical types of speciation, with unimpaired gene flow in a randomly mating population, are also possible although they require new explanations other than those presented by the model of accumulation of incompatible mutations. This kind of (sympatric) speciation will not be contemplated in the present work.

Even if speciation does *not* *pro* *9* *utations*. *TJan.Tj.Tdges*

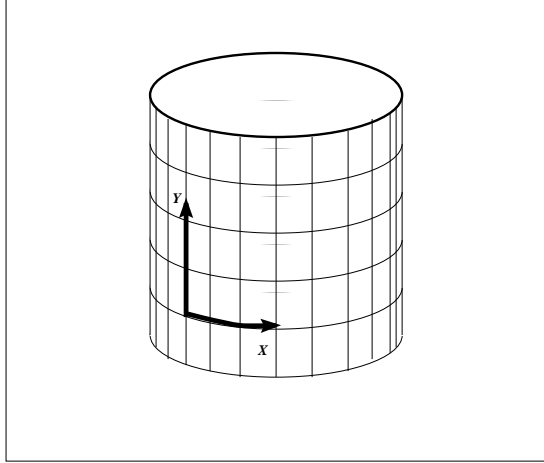

Figure 1: Cylindrical geometry of the environment.

the second law of thermodynamics, have been respected, while other features such as genetic encoding and agent behavior have been simplified for the sake of clarity in the analysis of the results. These are, of course, working assumptions, and no claim is made about their ultimate relevance in the process of speciation. One of the advantages of a computational model of this kind, as discussed later, is the flexibility in the relaxation of assumptions in order to expand it and compare new results with previous ones.

3.1 The Environment

In this model a population of agents “live”, “reproduce” and “die” in an artificial environment. As the intention is to study general cases of speciation and not allopatric speciation in particular; much thought was given to the design of an environment in which cases of parapatric speciation are allowed. The environment can be described as a grid of 2-D cylindrical geometry with a much larger dimension in the aperiodic coordinate (y) than in the periodic one (x), as shown in Figure 1. Both dimension are much larger still than the agent’s average single movement, (typical values are: $Agent's\ Movement = 1$; $X_{max} = 100$; $Y_{max} = 1000$).

The whole environment is subject to a continuous flow of energy. This energy is stored in evenly distributed reservoirs from which the agents may

extract a fixed amount of energy per unit of time for the costs of moving

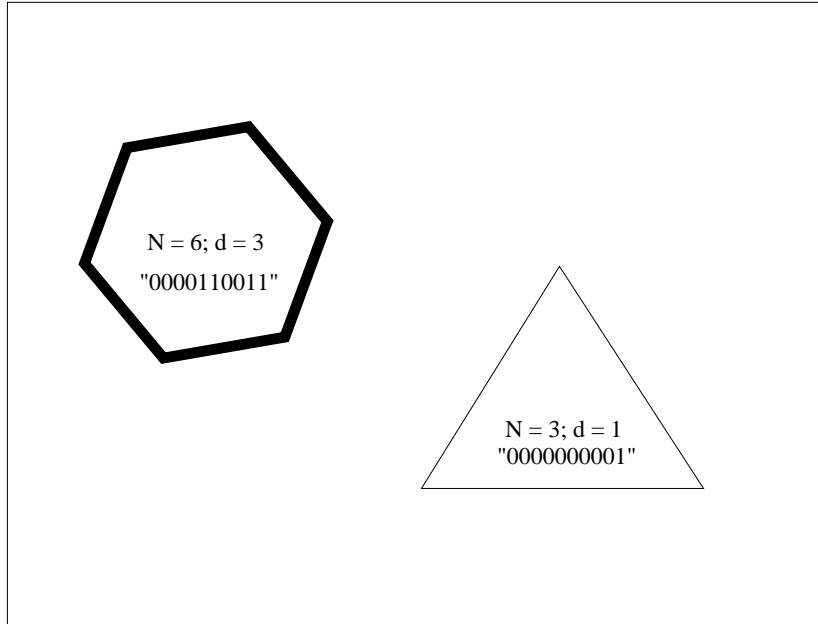

Figure 2: Examples of agents.

Some phenotypic features, however, remain constant for all

the first parent and transferred to the offspring, who initially shares the same environmental cell. The whole reproduction process is highly localized, an assumption that seems to be necessary for speciation to occur.



Figure 3: Whole population distribution. In this and the following figures the vertical axis corresponds to the aperiodic (y) axis of the environment (scale 1:20), and the horizontal axis corresponds to time steps (scale 1:20).

ancestor species.

In the non-uniform environment the population density is maintained but the environmental resources are reduced. This is done by decrementing the rate of replenishment of the energy reservoirs, thus providing the selective pressure for individuals to move to other areas with more resources. The first observed effect is an abrupt reduction in the size of the population. Gradually after that the area covered by the population starts to increase as a result of the diffusive effect of the random walk. This process of expansion follows a rule of proportionality to the square root of time.

In the run shown in Figures 3 to 8 (one of many yielding similar results) a population of 100 individual with $N = 11$ and $d = 3$ (11-3) is initially placed in the world between $y = 450$ and $y = 550$. In these figures the horizontal axis represents time, the vertical axis the y coordinate and the gray and black dots indicate that a number of individuals are occupying a cell with vertical position y at time t (darker dots meaning less individuals). Four major events are observed in this simulation. Around $t = 1000$ a subpopulation 3-3 appears towards the hotter side of the region occupied

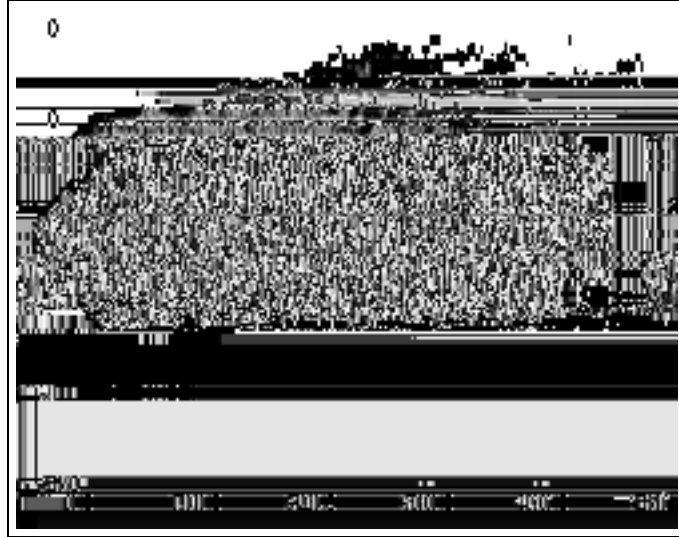

Figure 4: Distribution of ancestor population, 11-3, originally distributed between $y = 450$ and $y = 550$.

by the population 11-3, and begins to expand. This cannot yet be called a case of speciation for reasons explained below. It is important to notice that both populations share a significant amount of territory. Then at $t \approx 5000$ a population 3-1 appears towards the hotter side of the area occupied by the agents 3-3 and a very short time after that another population, this time 7-1, is born between these two. The colder side of 11-3 is most of the time being conquered by this population, but at $t \approx 5000$ a population 11-7 fills the coldest regions of the world.

Can any of these events be classified as a case of speciation? Only some of them. A simple genetic analysis can show that no two neighbouring population are reproductively isolated. As it turns out any offspring whose parents belong to different neighbour populations will itself belong to one of them. As an example let us consider the case between the populations 11-3 and 11-7. The respective genotypes are “0010000011”

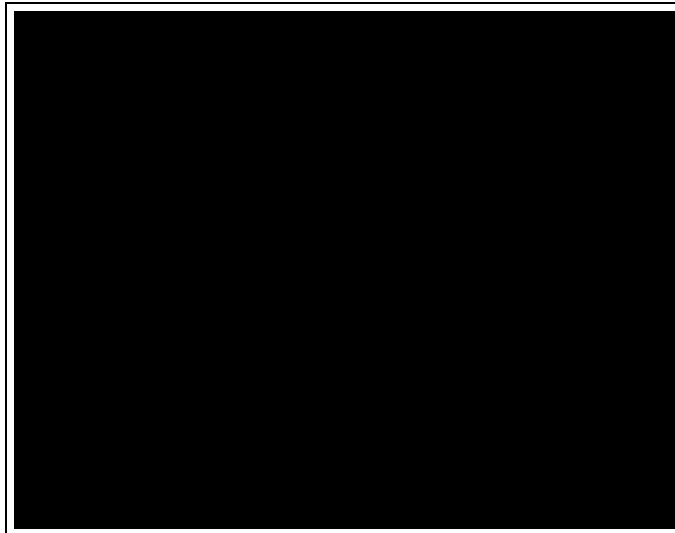

Figure 5: Distribution of population, 3-3, appearing first at $t \approx 1000$. Note that there is a zone of coexistence with population 11-3.

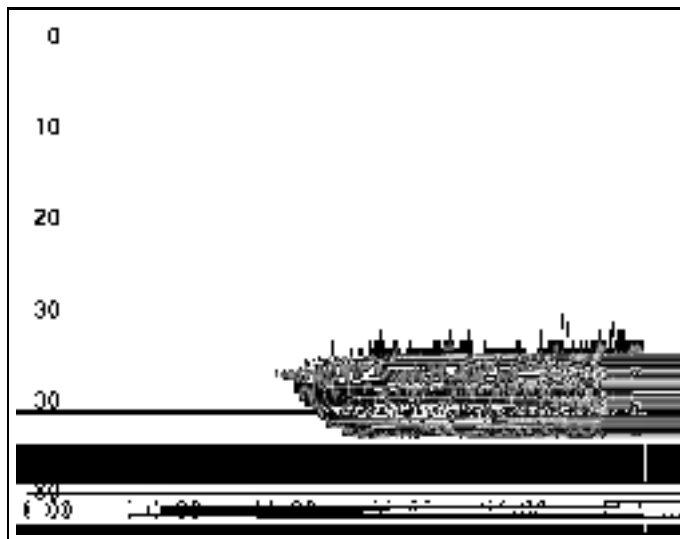

Figure 6: Distribution of population, 3-1, appearing around $t \approx 5000$.

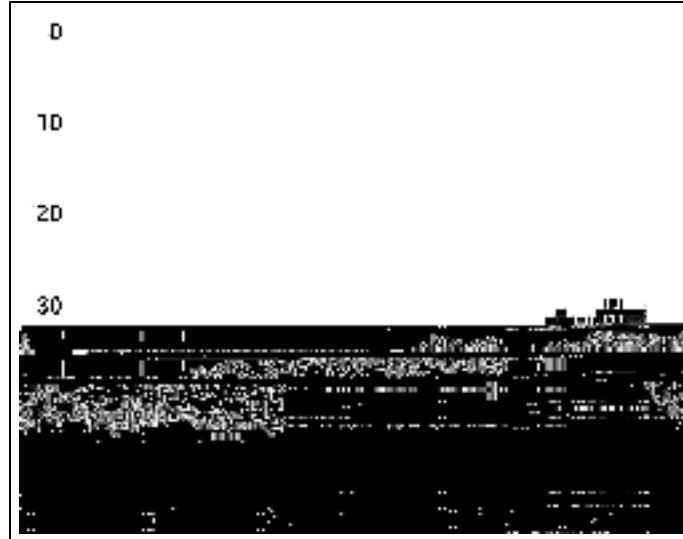

Figure 7: Distribution of population, 7-1, appearing around $t \approx 5000$ between population 3-3 and 3-1. It probably derives from 3-1 as the genetic distance is shorter with this population than with 3-3

type of genetic encoding used in this model, but it will be argued that this is the general case in parapatric speciation).

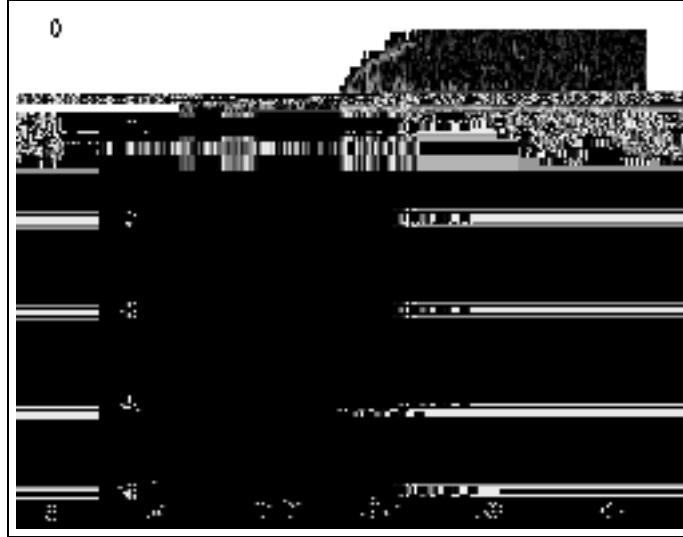

Figure 8: Distribution of population, 11-7, appearing around $t \approx 5000$, towards the hotter side of the ancestor population.

and the lack of a developmental process, this “hybrid” genotype will in fact be viable, but it will have a low probability of existing beyond the first generation. In this case it makes sense to speak of different species.

It is interesting to notice that if speciation is to occur parapatrically, without any real physical barriers between populations, then there are two necessary requirements for the first mutations in the ancestor genotype to survive, namely: (1) these mutations must translate into an adaptive or viable

the environment.

5 Discussion

The model presented in this paper does not include any mechanisms of development from genotype to phenotype. It is to be expected that the true nature of biological speciation: the inviability or infertility of hybrids, will not be replicated in these simulations. As stated by Dobzhansky (Dobzhansky, 1951):

“In the course of evolution, the function of a gene in the development may undergo such changes that the gene may subtend developmental processes other than those with which it was previously concerned. If the gene functions in two or more races or species, the gene system may become no longer compatible in hybrids.” (p. 207).

However, on account of an effect that may be considered similar to this one when viewed over evolutionary periods, namely the low fitness of hybrids, speciation is achieved within this computational model. It is possible, in future implementations, to include some simple developmental rules, such as a checking of genotype compatibility, or “fertility genes”, or more complex behaviors, such as mate choice, that may provide a closer approximation to the real case. It is the assumption of the present work that such changes to the model will not provide significant qualitative differences in the evolutionary dynamics.

Although most cases of speciation in nature are thought to be allopatric, it was the purpose of these experiments to concentrate on the possibility of parapatric speciation and in this way illustrate verbally supported arguments (Barton, 1988) from a dynamical systems point of view. One interesting effect highlighted by this approach which, although not new, is usually overlooked, is the need for newly mutated genotype to be able to crossbreed with the ancestor genotype if a new population is to be formed, and then, by definition, constituting only a case of “subspecies” or polytypic species. It is important to notice that this shows that better adaptation at the individual level does not necessarily mean better survival value of the genes. Between a neutral mutation capable of being replicated with the ancestor genotype and an adaptive mutation unable to do so, the first will have more chances of being propagated. This dynamical effect prevents the

with both, there is the possibility of speciation and this may be viewed as the emergence of allopatricity without prior physical barriers. This adds some qualitative considerations to the Dobzhansky-Muller model as presented by Orr (Orr, 1995); although in principle only a pair of incompatible mutations is sufficient for speciation to occur, this is

On the other hand, flexibility may turn out to be disadvantageous as the researcher may be “carried away” very easily, and be tempted to include many features in a given model making the analysis of results very difficult. The modelled mechanisms and processes need to be considered with care and assumptions about what is being included must be justified. One good heuristic method is to build the model incrementally, adding new features only once the dynamics of the previous stages are well understood. Then it is possible to have some basis of comparison as to the contribution of different ingredients in the final result. Such will be the case with this model, when other features (e.g. development mechanisms) are added.

6 Acknowledgements

I wish to thank Phil Husbands for his comments on previous versions of this article. This work is financially supported by the *Consejo Nacional de Investigaciones Científicas y Técnicas de la República Argentina* and the Argentine Ministry of Education.

Reference

Barton, N. H. (1988). Speciation. In A.A. Myers, P. G. (Ed.), *Analytical Biogeography*, pp. 185 – 218. ChapmanorktotoBa3.68509hil

Orr, H. A. (1995). The population genetics of speciation: The evolution of hybrid incompatibilities. *Genetics*, *139*, 1805 – 1813.